

CARBON FIBER SERIES

XAGA

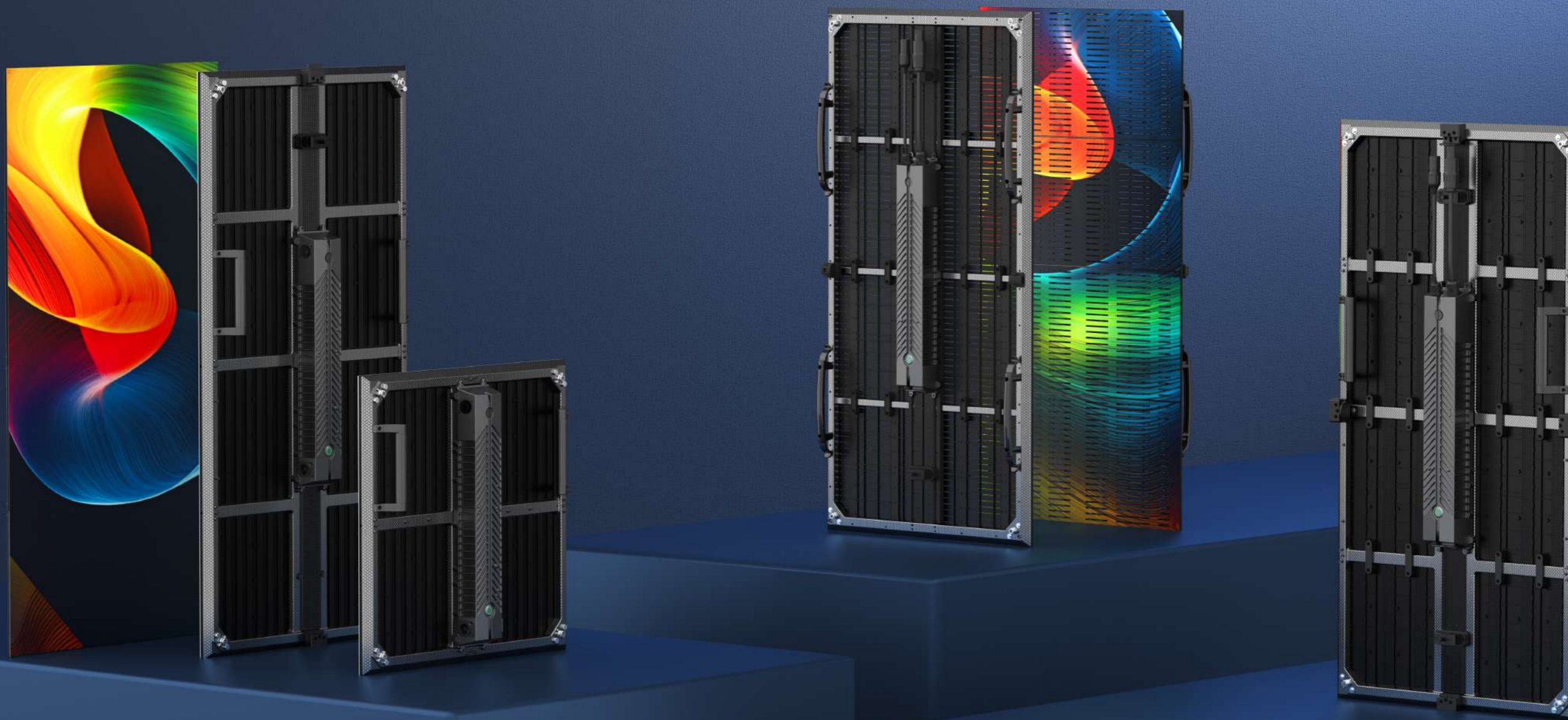

XAGA FEATURES

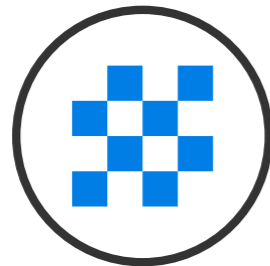

Ultra light carbon fiber

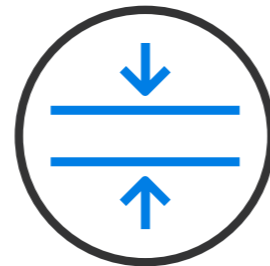

Thickness \leq 67mm

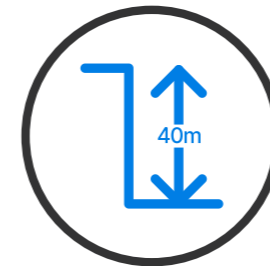

Hanging 40m height



Fatigue resistance



Corrosion Resistance



7680Hz Refresh rate

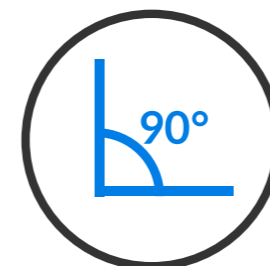

Bevel edge design



Quick installation

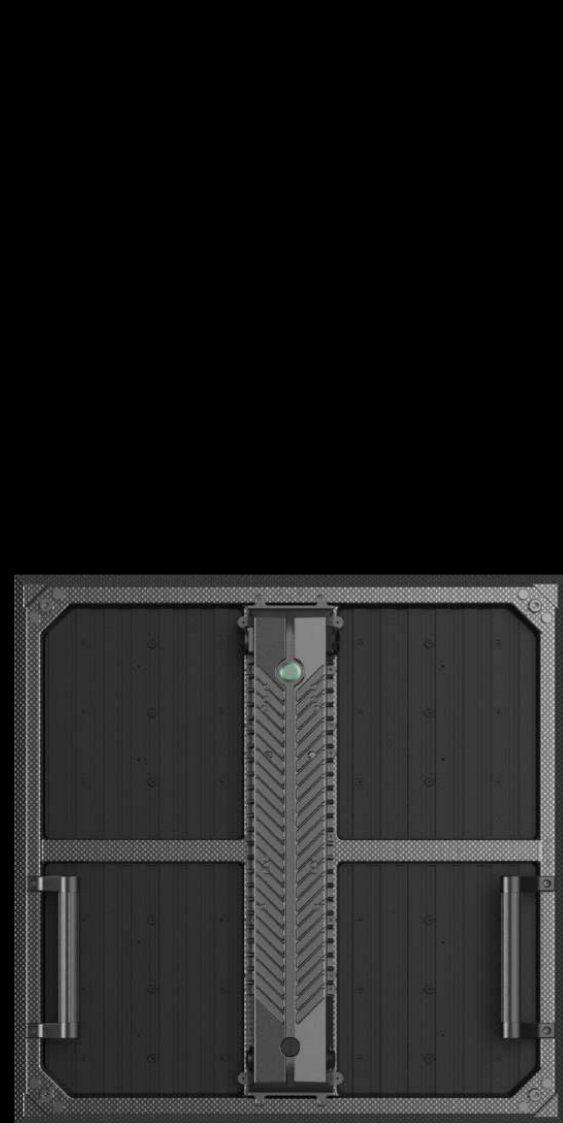

500×500

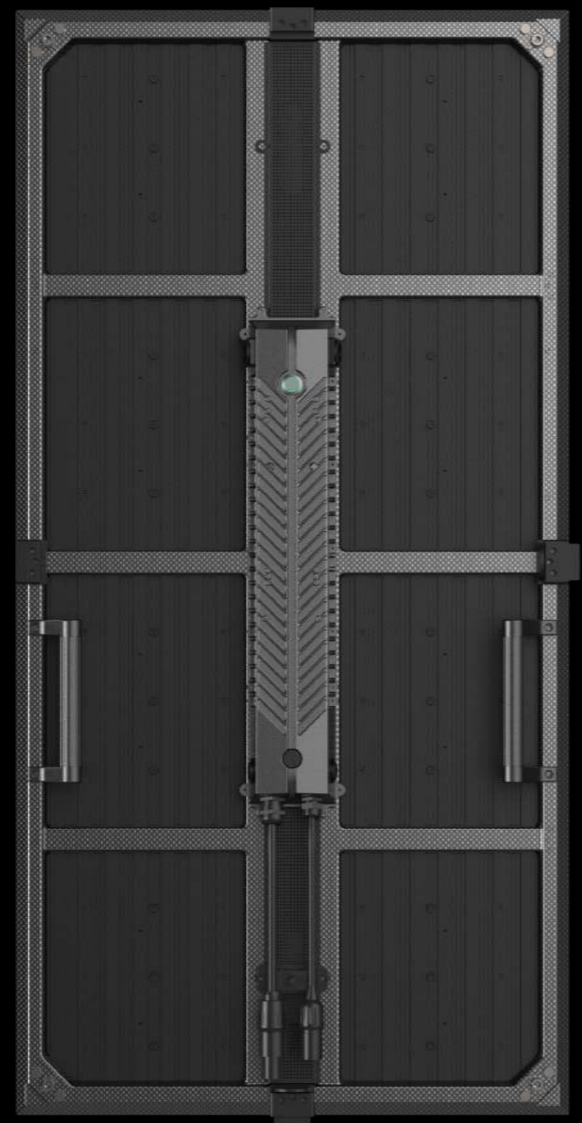

500×1000

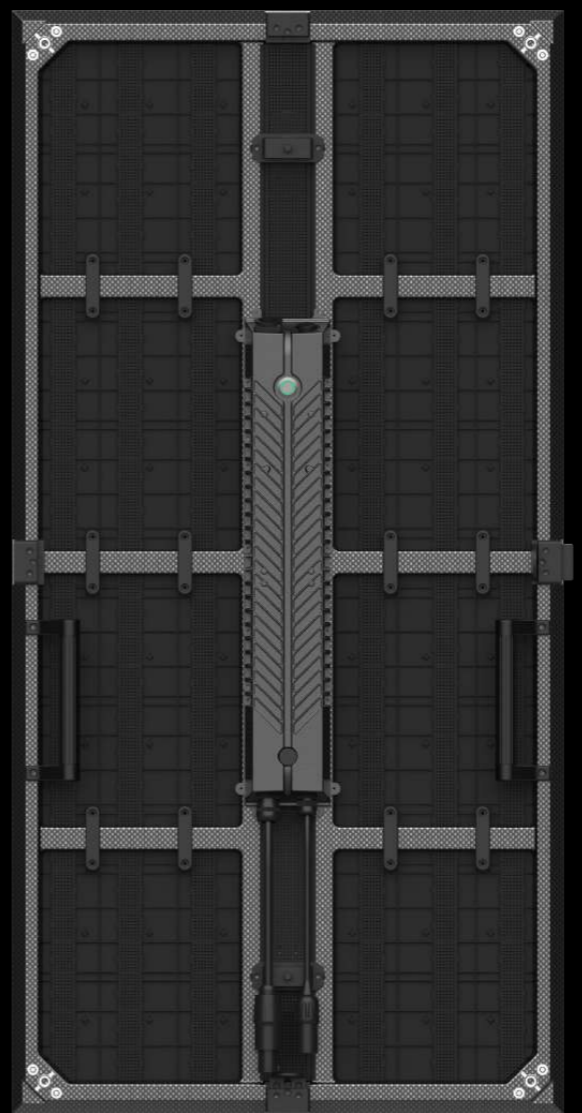

500×1000

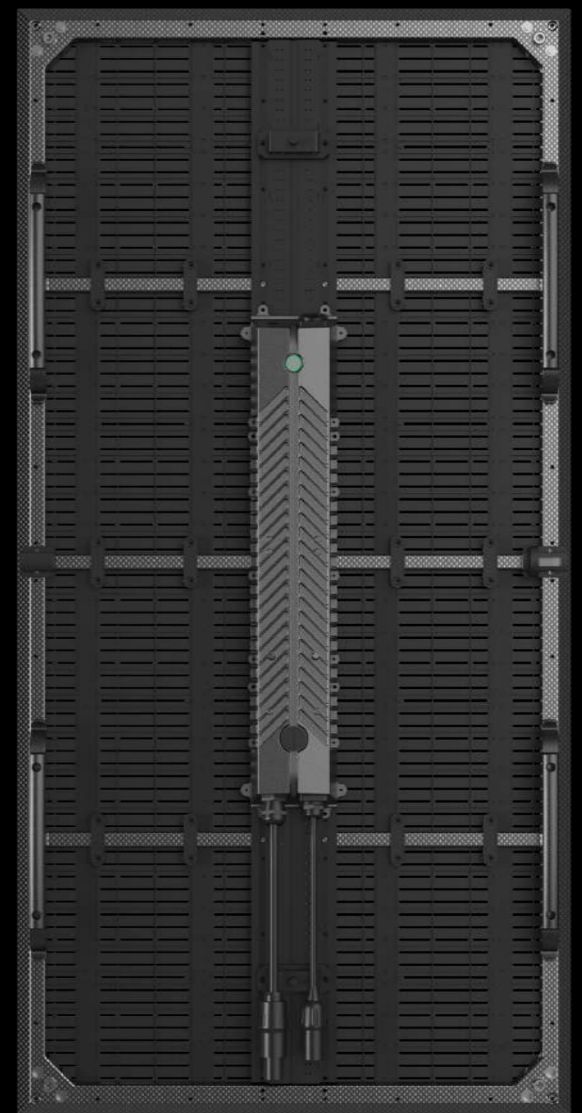

500×1000

Indoor LED screen



Outdoor LED screen

Carbon fiber skeleton for super thin and lightweight style
with ultra-high strength tensile force and high mechanical stability;

CARBON FIBER SKELETON

S



irm

The thickness is only **67mm**

ULTRA-THIN

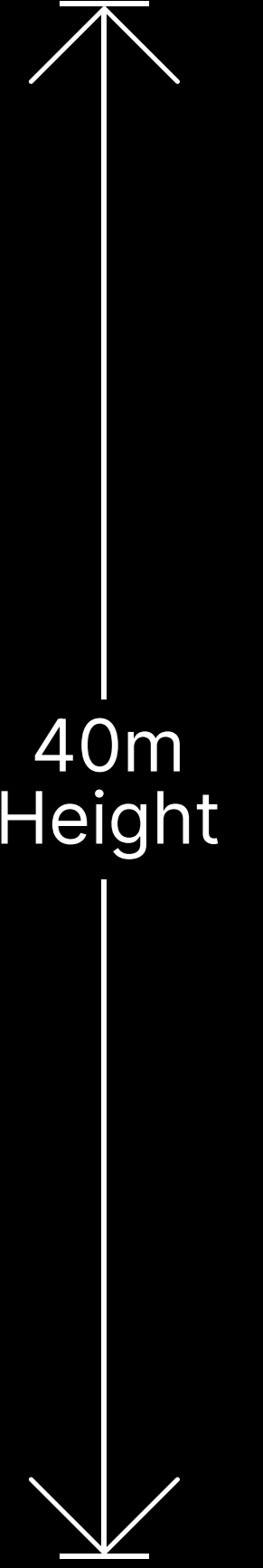
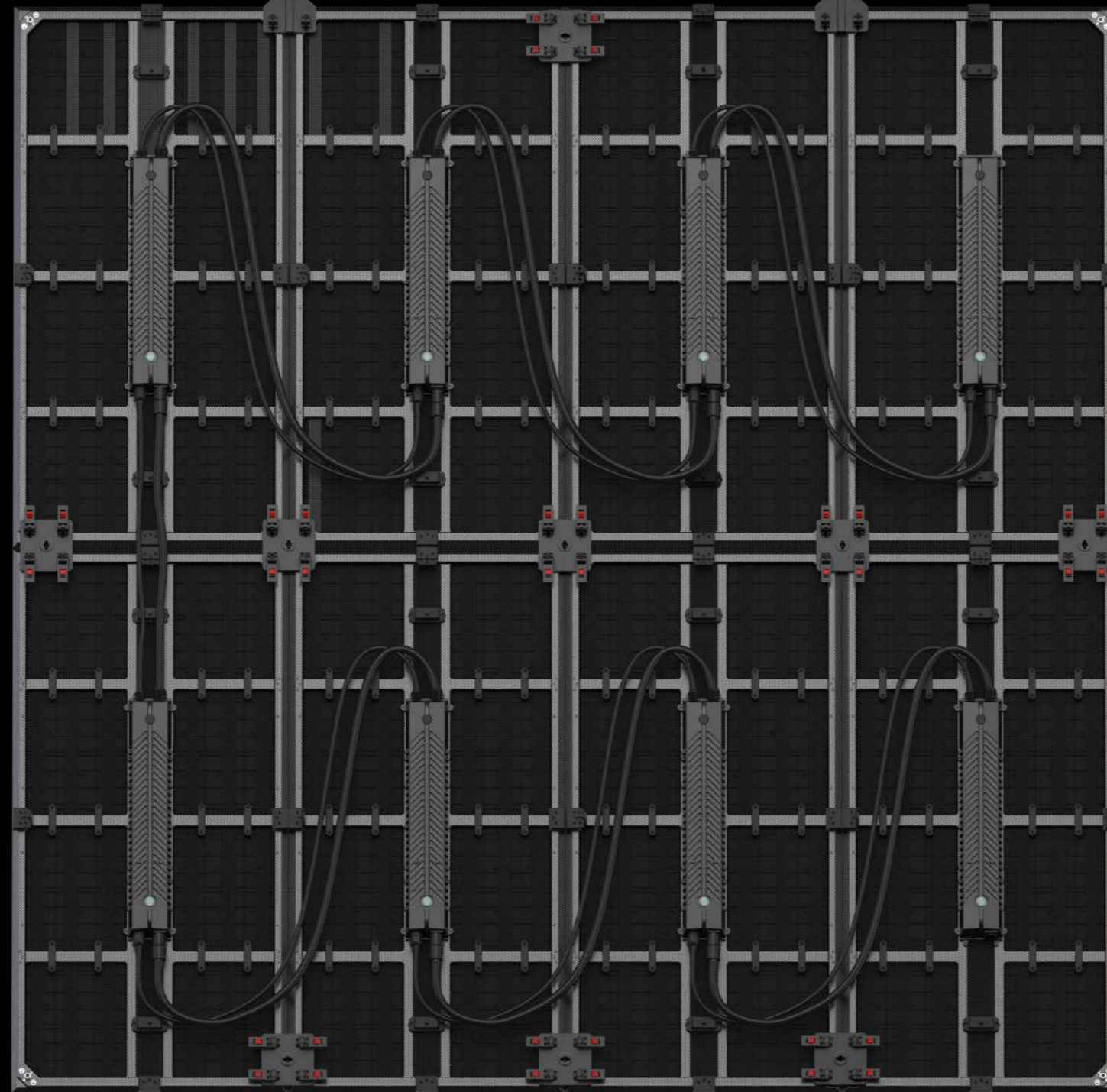
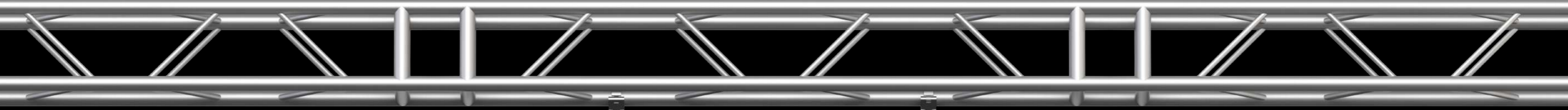

Good fatigue resistance

High streng tensile force and high mechanical stability, can hanging 40m height



Carbon fiber cabinet
strong and tough

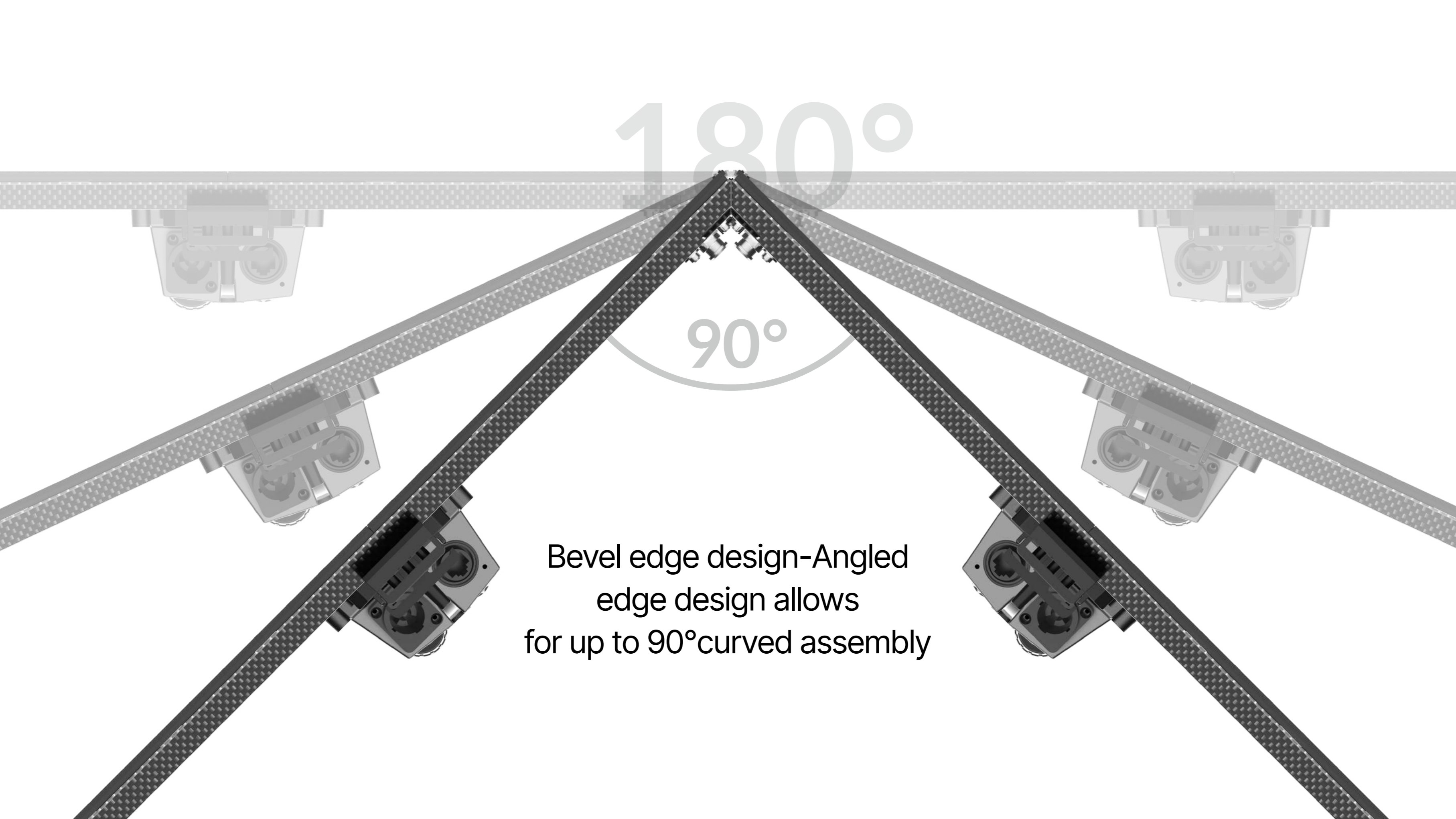

Bevel edge design-Angled
edge design allows
for up to 90° curved assembly

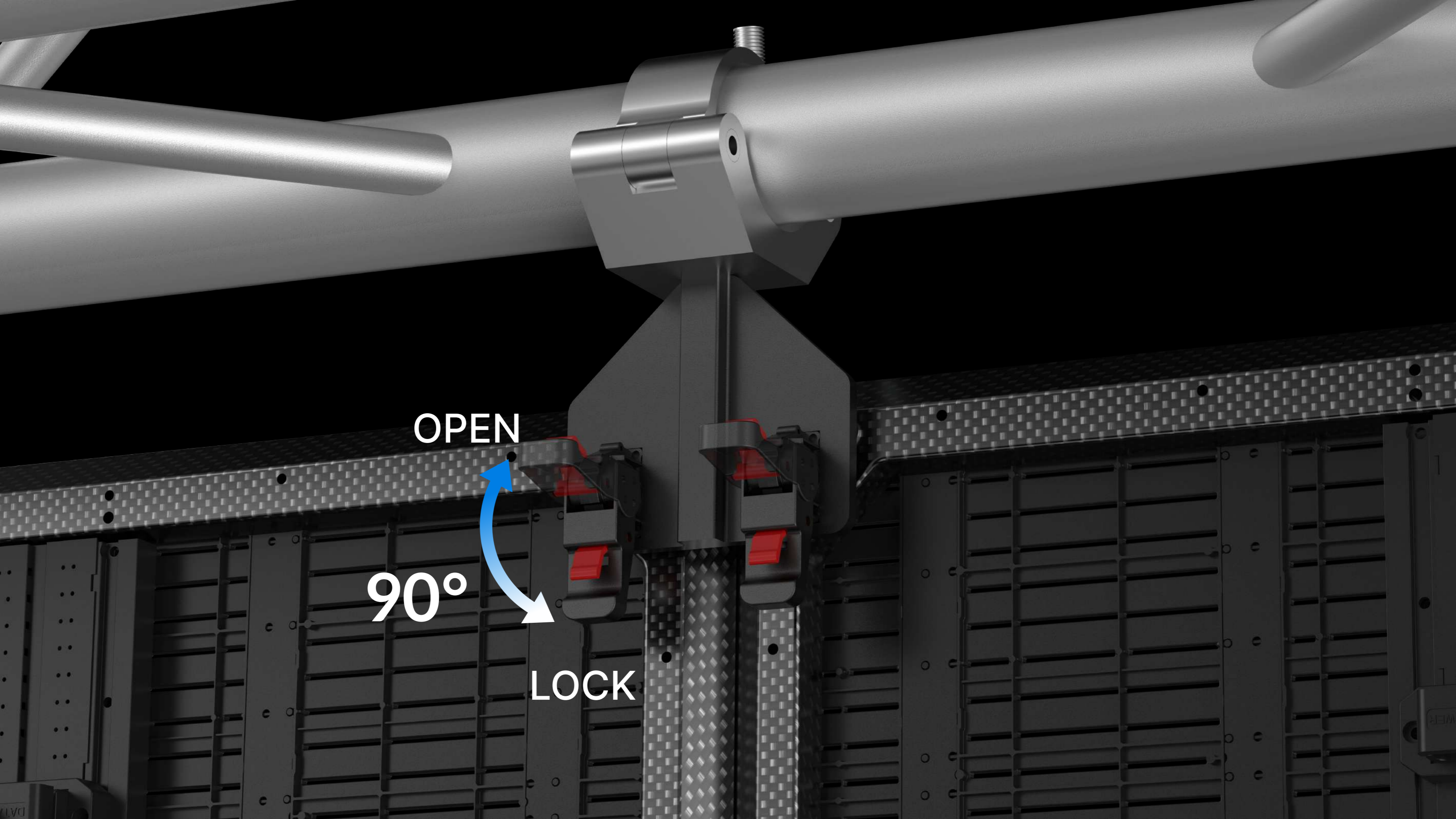

OPEN

90°

LOCK





Superwind resistance

INSTALLATION ACCESSORIES

01

FASTLock



02

Hanging FASTLock



03

Curved FASTLock



04

Simple connector



05

Simple hanging connector

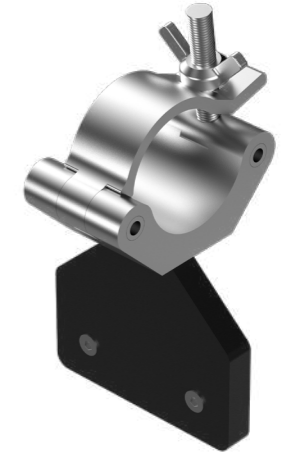

06

Curved connector

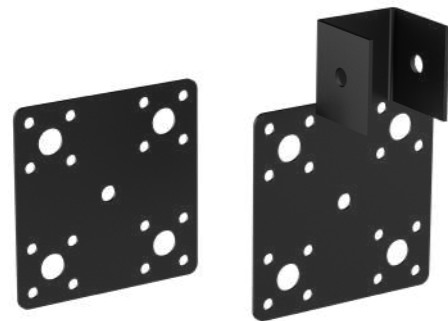

07

90 Degree connector
(convex)



08

270 Degree connector
(concave)



09

Cube connector

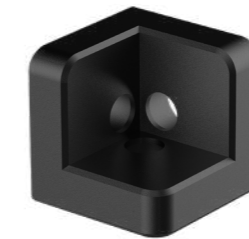

10

Ceiling connector

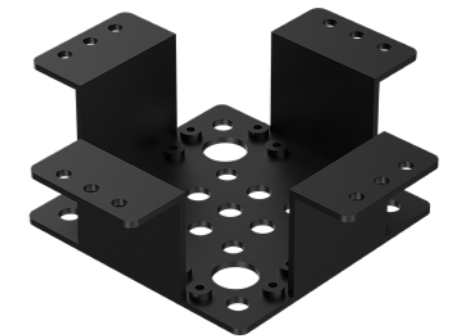

INSTALLATION METHOD

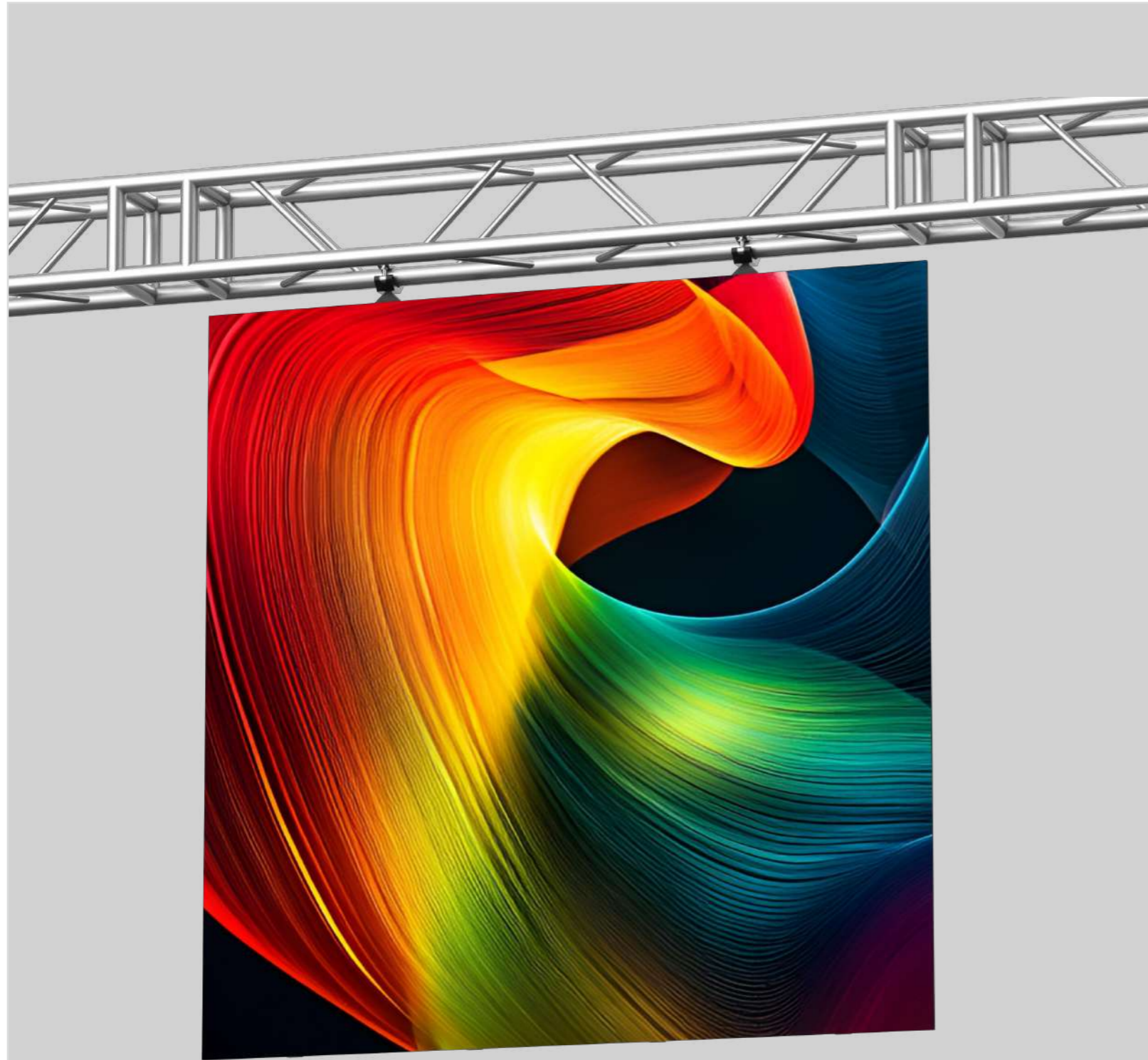

Hanging installation

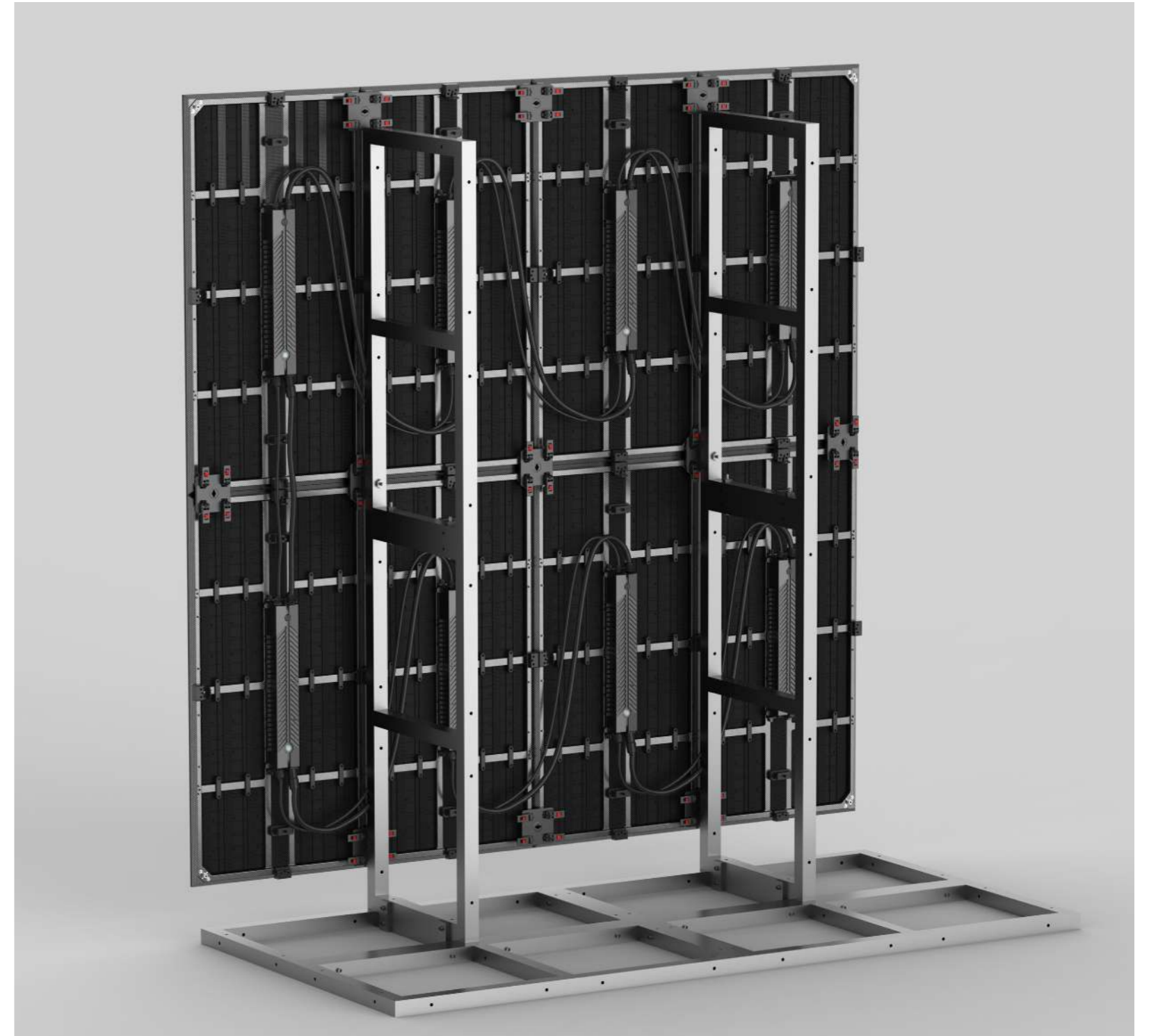

Stacking installation

BACK MAINTENANCE

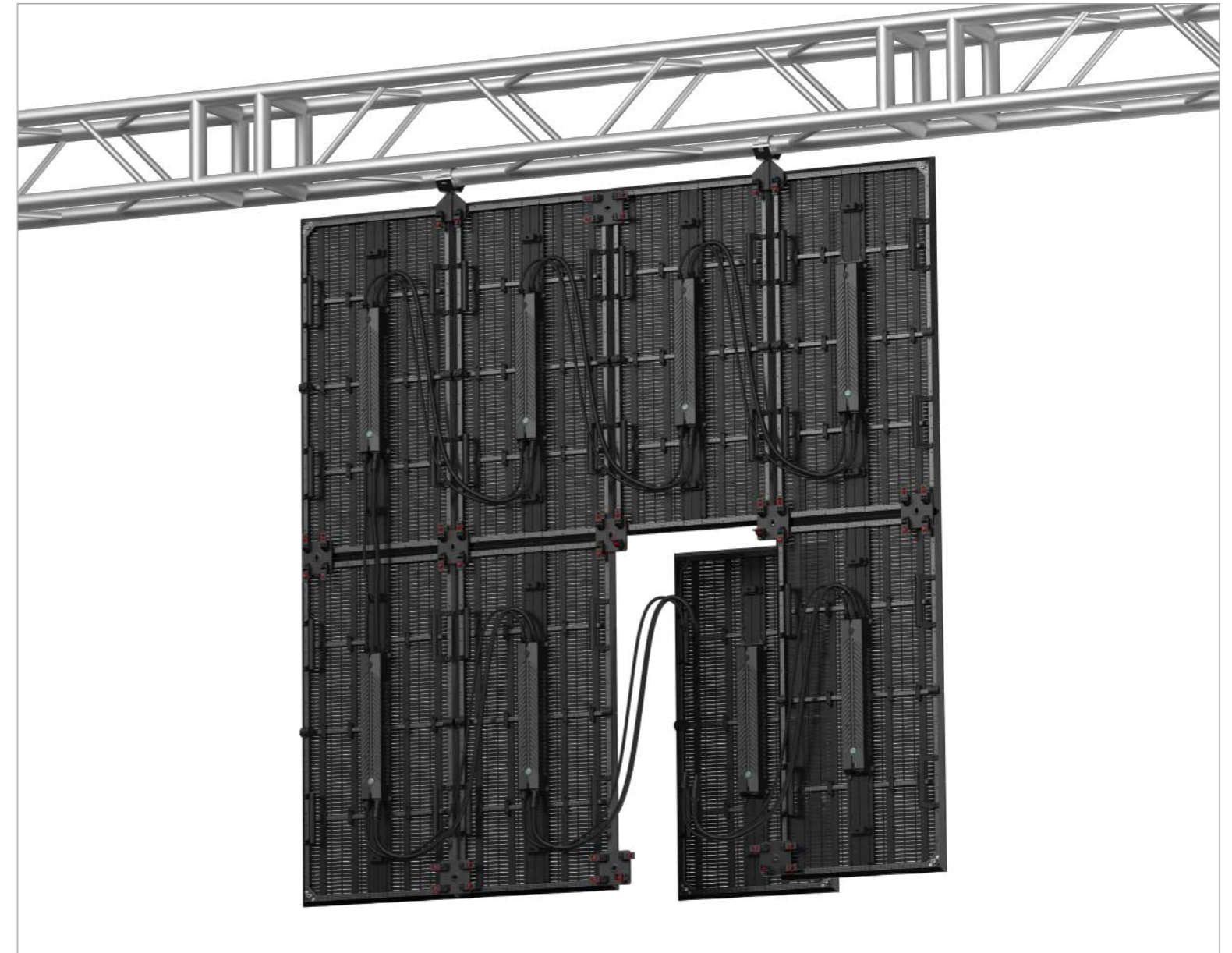
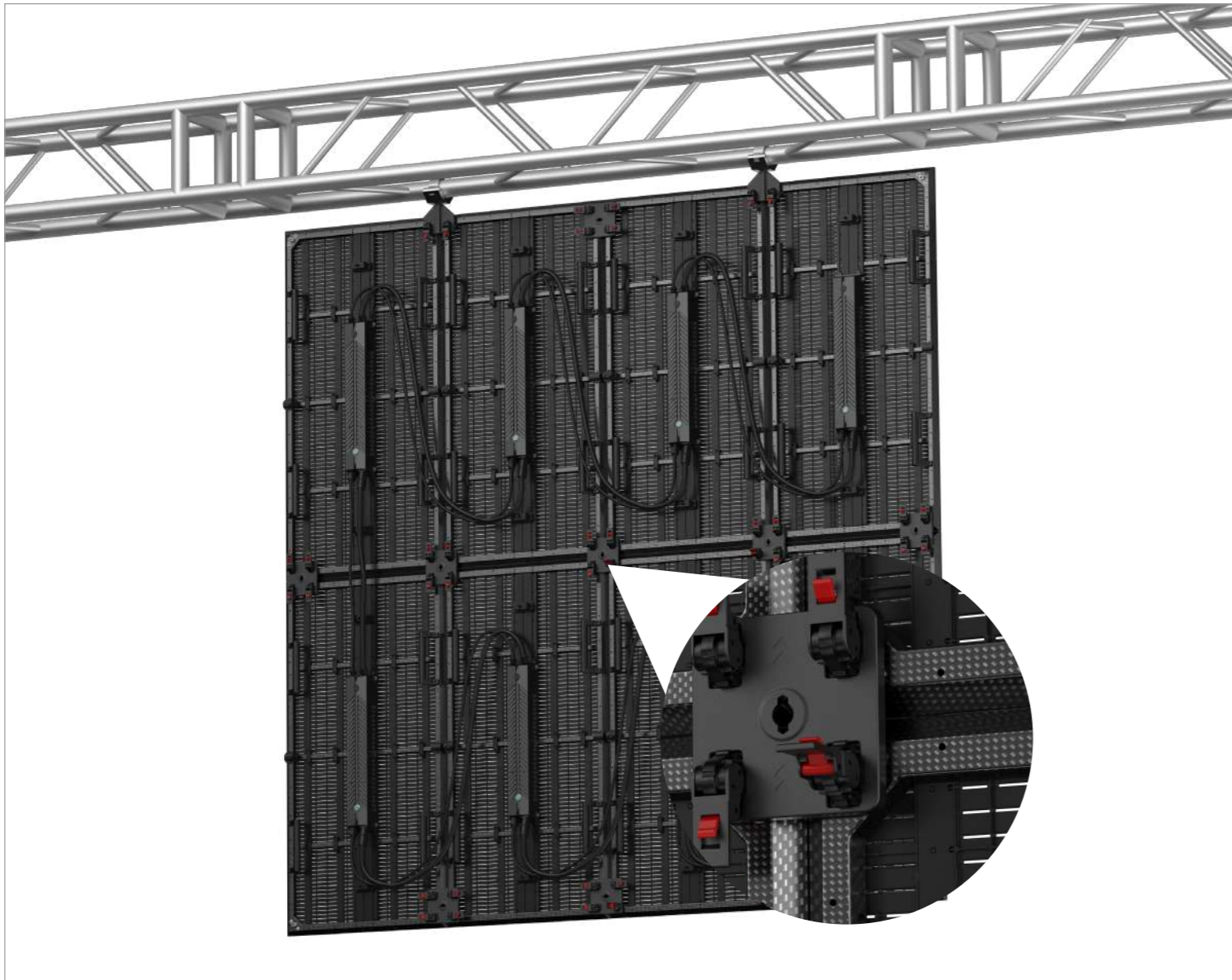

Step **01** Open the according 4×lock handles of the faulty panel and disconnect the power and signal cables.

Step **02** Hold the faulty panel and push forward in order to leave away the LED wall.

BACK MAINTENANCE

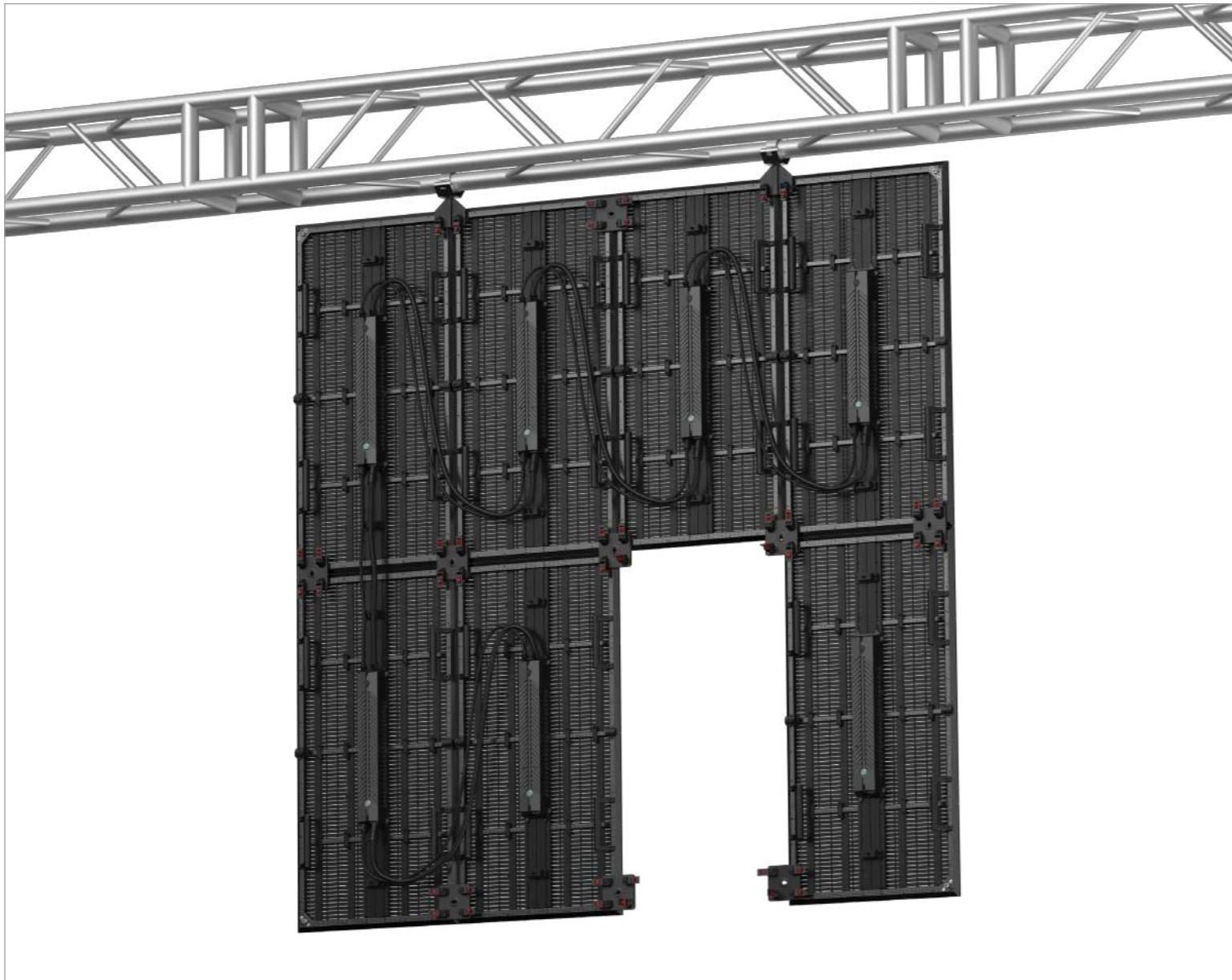

Step **03** Pull backward the faulty panel through the hole.

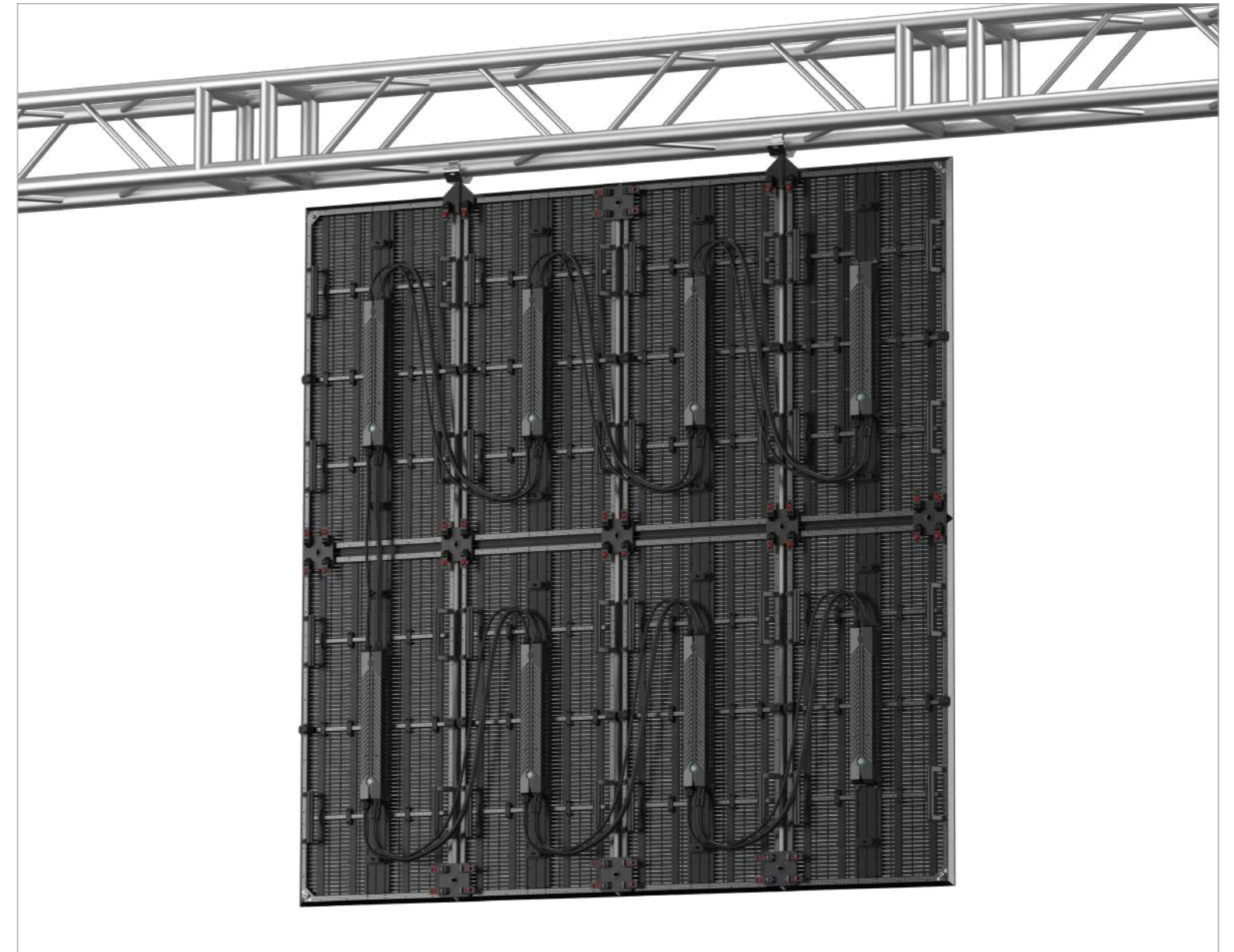

Step **04** Replace a new panel, tight the 4×lock handles and connect the power and signal cables.

APPLICATION SCENARIO



APPLICATION SCENARIO

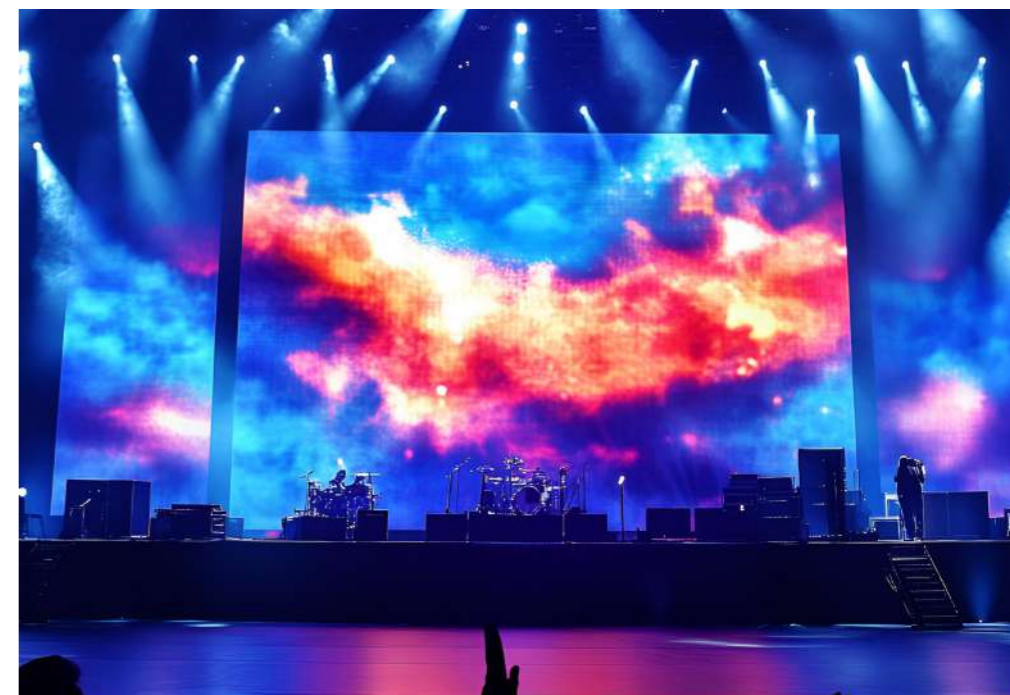

SPECIFICATIONS



Xaga-CFI

Xaga-CFLI

Product model	CFI1	CFI2	CFI3	CFLI3
Pixel pitch(mm)	1.95	2.604	3.91	3.91
Module size(mm)	250 × 250	500 × 250	500 × 250	500 × 250
Module resolution(dot)	128 x 128	192 × 96	128 × 64	128 × 64
Module assembly	2 × 2	1 × 2	1 × 2	1 × 4
Panel size(mm)	500 × 500	500 × 500	500 × 500	500 × 1000
Panel resolution(dot)	256 x256	192 × 192	128 × 128	128 × 256
LED type	SMD 1212	SMD 1515	SMD 2020	SMD 2020
Brightness(cd/m ²)	800~1000		≥800	
Contrast ratio		10000:1		5000:1
Support input	Composite,S-Vido,Component,VGA,DVI,HDMI,HD_SDI			
Horizontal viewing angle	160°			
Vertical viewing angle	160°			
Gray level(bit)	16			
Refresh rate	≥7680Hz			
Max. AC power consumption	≤650W/m ²		≤660W/m ²	
Avg. AC power consumption	≤280W/m ²		≤195W/m ²	
Input voltage	100 - 240 VAC, 50 ~ 60 Hz			
Operate temperature	-30°C~+50°C			
Storage temperature	-40~+80 °C			
Operating humidity	10~90% RH			
Protection grade	IP30			
Working environment	Indoor			
Cabinet material	Carbon fiber			
LED lifetime(hours)	100,000			
Weight(kg/m ²)	20	16	16	13



Notes: Specifications are slightly different according to different configurations.



Carbon fiber cabinet
strong and tough

SPECIFICATIONS

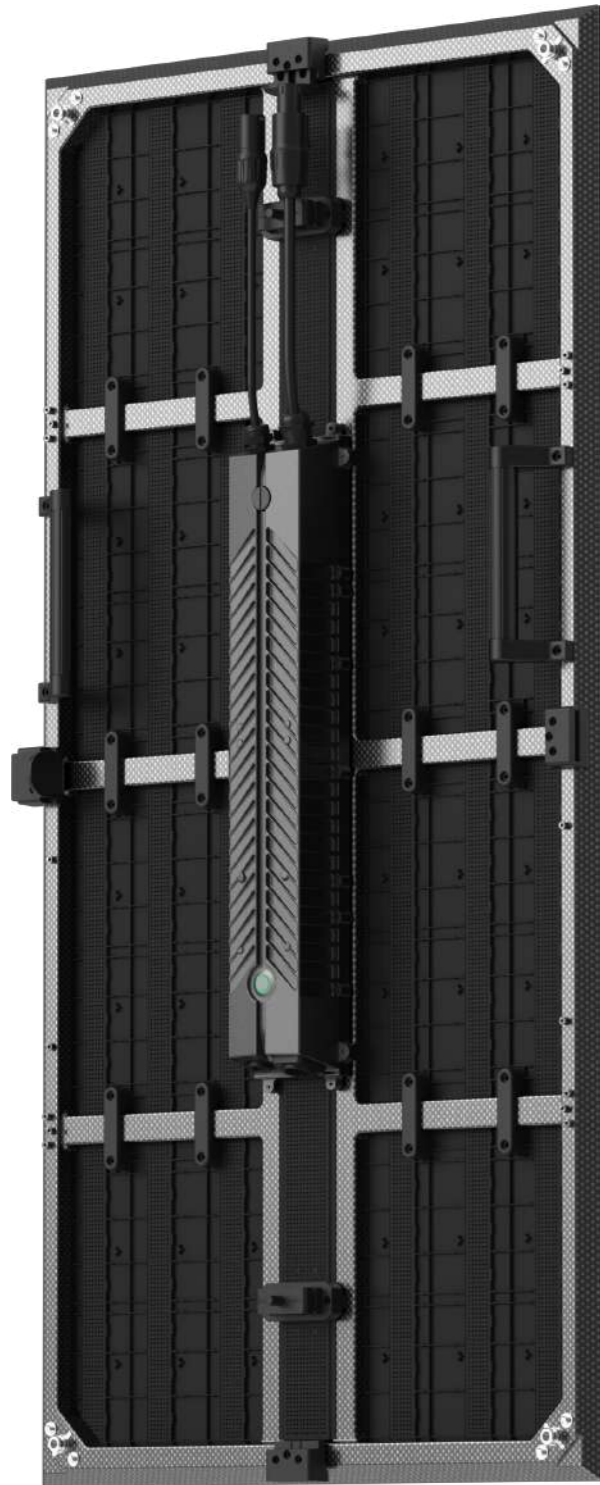

Xaga-CFL

Product model	CFL3	CFL4
Pixel pitch(mm)	3.91	4.81
Module size(mm)	500 × 250	500 × 250
Module resolution(dot)	128 × 64	104 × 52
Module assembly	1 × 4	1 × 4
Panel size(mm)	500 × 1000	500 × 1000
Panel resolution(dot)	128 × 256	104 × 208
LED type	SMD1415	SMD1921
Brightness(cd/m ²)	4500	5000
Contrast ratio	5000:1	
Support input	Composite,S-Vido,Component,VGA,DVI,HDMI,HD_SDI	
Horizontal viewing angle	160°	
Vertical viewing angle	160°	
Gray level(bit)	16	
Refresh rate	≥7680Hz	
Max. AC power consumption	≤700W/m ²	
Avg. AC power consumption	≤250W/m ²	
Input voltage	100 - 240 VAC, 50 ~ 60 Hz	
Operate temperature	-30°C~+50°C	
Storage temperature	-40~+80 °C	
Operating humidity	10~90% RH	
Protection grade	IP65	
Working environment	Outdoor	
Cabinet material	Carbon fiber	
LED lifetime(hours)	100,000	
Weight(kg/m ²)	14	



Notes: Specifications are slightly different according to different configurations.

SPECIFICATIONS

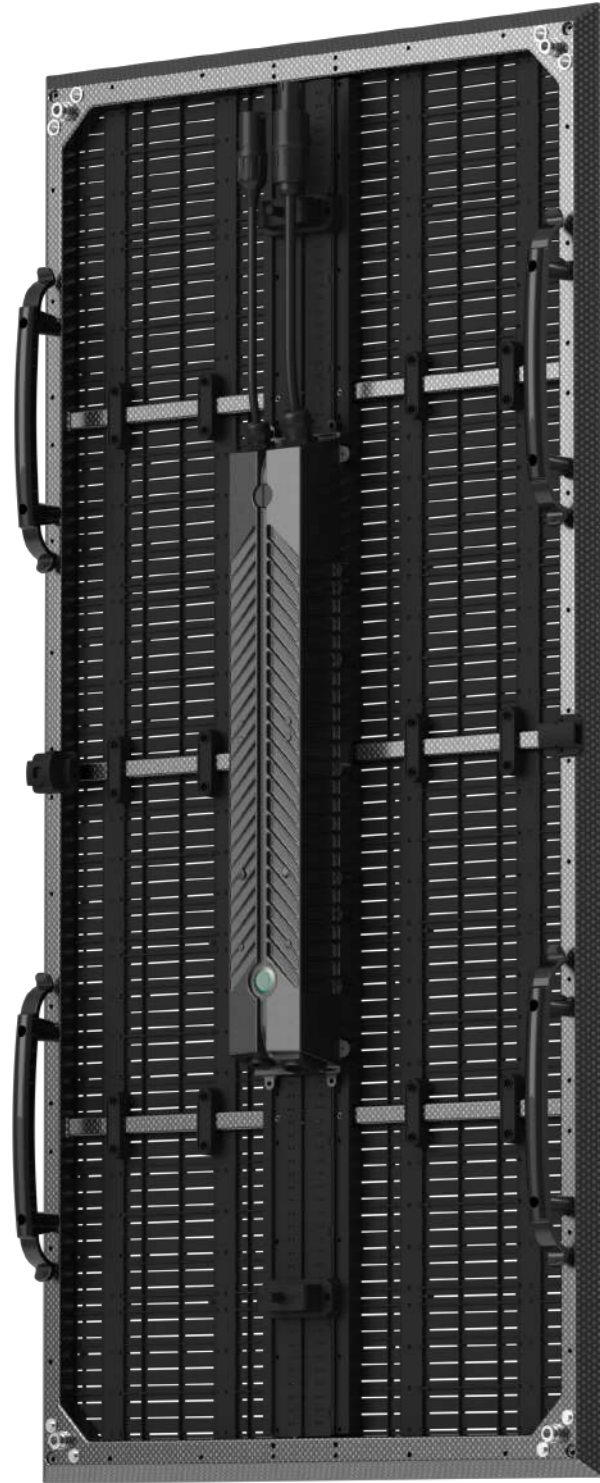

Xaga-CFTL

Product model	CFTL5	CFTL10
Pixel pitch(mm)	5.68	10.4
Module size(mm)	500 × 250	500 × 250
Module resolution(dot)	88 × 44	48 × 24
Module assembly	1 × 4	1 × 4
Panel size(mm)	500 × 1000	500 × 1000
Panel resolution(dot)	88 × 176	48 × 96
LED type	SMD1921	SMD3535
Brightness(cd/m ²)	5000	5000
Contrast ratio	5000:1	
Support input	Composite,S-Vido,Component,VGA,DVI,HDMI,HD_SDI	
Horizontal viewing angle	160°	
Vertical viewing angle	160°	
Gray level(bit)	16	
Refresh rate	≥7680Hz	
Max. AC power consumption	≤700W/m ²	
Avg. AC power consumption	≤250W/m ²	
Input voltage	100 - 240 VAC, 50 ~ 60 Hz	
Operate temperature	-30°C~+50°C	
Storage temperature	-40~+80 °C	
Operating humidity	10~90% RH	
Protection grade	IP65	
Working environment	Outdoor	
Cabinet material	Carbon fiber	
LED lifetime(hours)	100,000	
Weight(kg/m ²)	12	



Notes: Specifications are slightly different according to different configurations.

DIMENSIONS

CFI Series

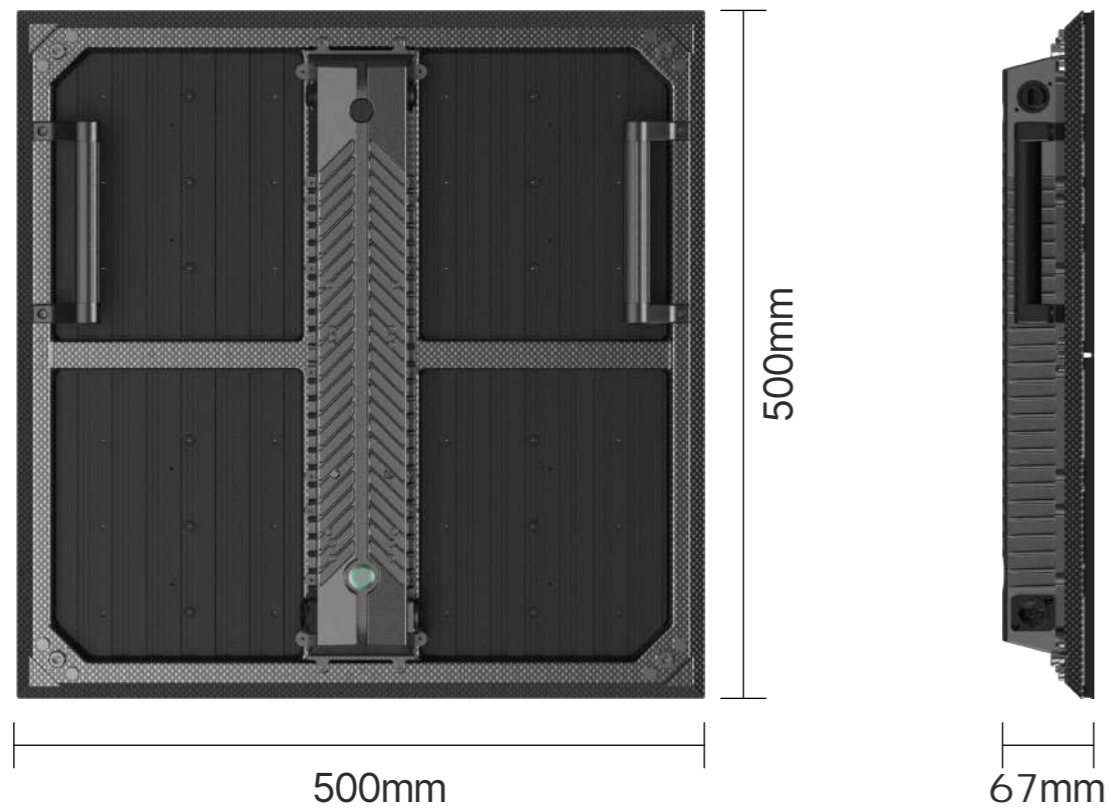

CFLI/CFL/CFTL Series







THANKS

We are looking forward to establishing
successful partnership with you!



 www.visualworld.com.cn
 +86 755 23052717
 sales@ledvworld.com

Visual World Co., Ltd.

2nd Floor, Building A, Tianyou Chuangke Hi-tech
Industrial Park, No.2 Lixin Road, Bao'an District,
Shenzhen 518103 China